



Laws of Motion

TOPIC 1

Ist, Ind & IIIrd Laws of Motion



1. A particle moving in the xy plane experiences a velocity dependent force $\vec{F} = k(v_y\hat{i} + v_x\hat{j})$, where v_x and v_y are x and y components of its velocity \vec{v} . If \vec{a} is the acceleration of the particle, then which of the following statements is true for the particle? [Sep. 06, 2020 (II)]

- (a) quantity $\vec{v} \times \vec{a}$ is constant in time
 (b) \vec{F} arises due to a magnetic field
 (c) kinetic energy of particle is constant in time
 (d) quantity $\vec{v} \cdot \vec{a}$ is constant in time

2. A spaceship in space sweeps stationary interplanetary dust.

As a result, its mass increases at a rate $\frac{dM(t)}{dt} = bv^2(t)$, where $v(t)$ is its instantaneous velocity. The instantaneous acceleration of the satellite is : [Sep. 05, 2020 (II)]

- (a) $-bv^3(t)$ (b) $-\frac{bv^3}{M(t)}$
 (c) $-\frac{2bv^3}{M(t)}$ (d) $-\frac{bv^3}{2M(t)}$

3. A small ball of mass m is thrown upward with velocity u from the ground. The ball experiences a resistive force mkv^2 where v is its speed. The maximum height attained by the ball is : [Sep. 04, 2020 (II)]

- (a) $\frac{1}{2k} \tan^{-1} \frac{ku^2}{g}$ (b) $\frac{1}{k} \ln \left(1 + \frac{ku^2}{2g} \right)$
 (c) $\frac{1}{k} \tan^{-1} \frac{ku^2}{2g}$ (d) $\frac{1}{2k} \ln \left(1 + \frac{ku^2}{g} \right)$

4. A ball is thrown upward with an initial velocity V_0 from the surface of the earth. The motion of the ball is affected by a drag force equal to $m\gamma v^2$ (where m is mass of the ball, v is its instantaneous velocity and γ is a constant). Time taken by the ball to rise to its zenith is : [10 April 2019 I]

- (a) $\frac{1}{\sqrt{\gamma g}} \tan^{-1} \left(\sqrt{\frac{\gamma}{g}} V_0 \right)$ (b) $\frac{1}{\sqrt{\gamma g}} \sin^{-1} \left(\sqrt{\frac{\gamma}{g}} V_0 \right)$
 (c) $\frac{1}{\sqrt{\gamma g}} \ln \left(1 + \sqrt{\frac{\gamma}{g}} V_0 \right)$ (d) $\frac{1}{\sqrt{2\gamma g}} \tan^{-1} \left(\sqrt{\frac{2\gamma}{g}} V_0 \right)$

5. A ball is thrown vertically up (taken as $+z$ -axis) from the ground. The correct momentum-height (p-h) diagram is: [9 April 2019 I]

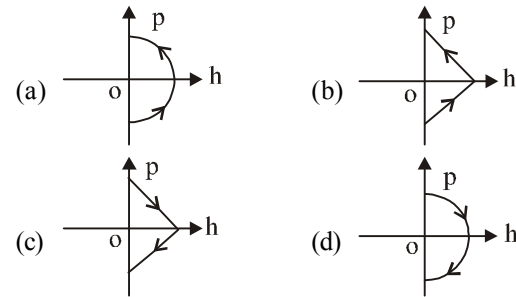

6. A particle of mass m is moving in a straight line with momentum p . Starting at time $t=0$, a force $F = kt$ acts in the same direction on the moving particle during time interval T so that its momentum changes from p to $3p$. Here k is a constant. The value of T is : [11 Jan. 2019 II]

- (a) $2\sqrt{\frac{k}{p}}$ (b) $2\sqrt{\frac{p}{k}}$
 (c) $\sqrt{\frac{2k}{p}}$ (d) $\sqrt{\frac{2p}{k}}$

7. A particle of mass m is acted upon by a force F given by the empirical law $F = \frac{R}{t^2} v(t)$. If this law is to be tested experimentally by observing the motion starting from rest, the best way is to plot : [Online April 10, 2016]

- (a) $\log v(t)$ against $\frac{1}{t}$ (b) $v(t)$ against t^2
 (c) $\log v(t)$ against $\frac{1}{t^2}$ (d) $\log v(t)$ against t

8. A large number (n) of identical beads, each of mass m and radius r are strung on a thin smooth rigid horizontal rod of length L ($L \gg r$) and are at rest at random positions. The rod is mounted between two rigid supports (see figure). If one of the beads is now given a speed v , the average force experienced by each support after a long time is (assume all collisions are elastic):
[Online April 11, 2015]

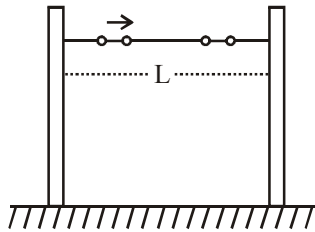

- (a) $\frac{mv^2}{2(L-nr)}$ (b) $\frac{mv^2}{L-2nr}$
 (c) $\frac{mv^2}{L-nr}$ (d) zero
9. A body of mass 5 kg under the action of constant force $\vec{F} = F_x\hat{i} + F_y\hat{j}$ has velocity at $t = 0$ s as $\vec{v} = (6\hat{i} - 2\hat{j})$ m/s and at $t = 10$ s as $\vec{v} = +6\hat{j}$ m/s. The force \vec{F} is:
[Online April 11, 2014]

- (a) $(-3\hat{j} + 4\hat{j})$ N (b) $(-\frac{3}{5}\hat{i} + \frac{4}{5}\hat{j})$ N
 (c) $(3\hat{i} - 4\hat{j})$ N (d) $(\frac{3}{5}\hat{i} - \frac{4}{5}\hat{j})$ N

10. A particle of mass m is at rest at the origin at time $t = 0$. It is subjected to a force $F(t) = F_0 e^{-bt}$ in the x direction. Its speed $v(t)$ is depicted by which of the following curves?
[2012]

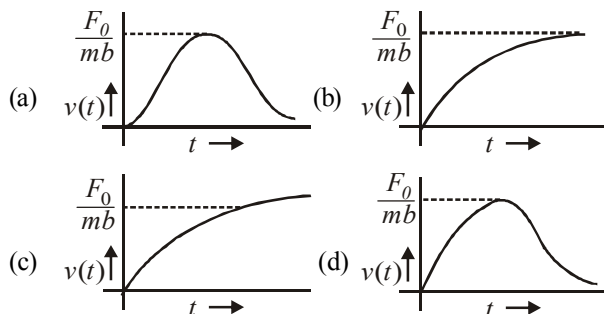

11. This question has Statement 1 and Statement 2. Of the four choices given after the Statements, choose the one that best describes the two Statements.
Statement 1: If you push on a cart being pulled by a horse so that it does not move, the cart pushes you back with an equal and opposite force.
Statement 2: The cart does not move because the force described in statement 1 cancel each other.
 [Online May 26, 2012]

- (a) Statement 1 is true, Statement 2 is true, Statement 2 is the correct explanation of Statement 1.
 (b) Statement 1 is false, Statement 2 is true.
 (c) Statement 1 is true, Statement 2 is false.
 (d) Statement 1 is true, Statement 2 is true, Statement 2 is not the correct explanation of Statement 1.
12. Two fixed frictionless inclined planes making an angle 30° and 60° with the vertical are shown in the figure. Two blocks A and B are placed on the two planes. What is the relative vertical acceleration of A with respect to B? [2010]

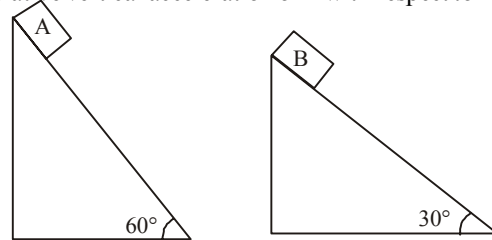

- (a) 4.9 ms^{-2} in horizontal direction
 (b) 9.8 ms^{-2} in vertical direction
 (c) Zero
 (d) 4.9 ms^{-2} in vertical direction
13. A ball of mass 0.2 kg is thrown vertically upwards by applying a force by hand. If the hand moves 0.2 m while applying the force and the ball goes upto 2 m height further, find the magnitude of the force. (Consider $g = 10 \text{ m/s}^2$). [2006]
 (a) 4 N (b) 16 N (c) 20 N (d) 22 N
14. A player caught a cricket ball of mass 150 g moving at a rate of 20 m/s. If the catching process is completed in 0.1 s, the force of the blow exerted by the ball on the hand of the player is equal to [2006]
 (a) 150 N (b) 3 N (c) 30 N (d) 300 N
15. A particle of mass 0.3 kg subject to a force $F = -kx$ with $k = 15 \text{ N/m}$. What will be its initial acceleration if it is released from a point 20 cm away from the origin? [2005]
 (a) 15 m/s^2 (b) 3 m/s^2 (c) 10 m/s^2 (d) 5 m/s^2
16. A block is kept on a frictionless inclined surface with angle of inclination ' α '. The incline is given an acceleration ' a ' to keep the block stationary. Then a is equal to [2005]

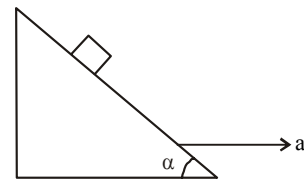

- (a) $g \operatorname{cosec} \alpha$ (b) $g / \tan \alpha$
 (c) $g \tan \alpha$ (d) g
17. A rocket with a lift-off mass 3.5×10^4 kg is blasted upwards with an initial acceleration of 10 m/s^2 . Then the initial thrust of the blast is [2003]
 (a) 3.5×10^5 N (b) 7.0×10^5 N
 (c) 14.0×10^5 N (d) 1.75×10^5 N
18. Three forces start acting simultaneously on a particle moving with velocity, \vec{v} . These forces are represented in magnitude and direction by the three sides of a triangle ABC. The particle will now move with velocity [2003]

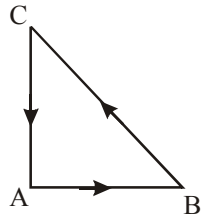

- (a) less than \bar{v}
 (b) greater than \bar{v}
 (c) $|\bar{v}|$ in the direction of the largest force BC
 (d) \bar{v} , remaining unchanged
19. A solid sphere, a hollow sphere and a ring are released from top of an inclined plane (frictionless) so that they slide down the plane. Then maximum acceleration down the plane is for (no rolling) [2002]
 (a) solid sphere (b) hollow sphere
 (c) ring (d) all same

TOPIC 2

Motion of Connected Bodies,
 Pulley & Equilibrium of
 Forces



20. A mass of 10 kg is suspended by a rope of length 4 m, from the ceiling. A force F is applied horizontally at the mid-point of the rope such that the top half of the rope makes an angle of 45° with the vertical. Then F equals: (Take $g = 10 \text{ ms}^{-2}$ and the rope to be massless) [7 Jan. 2020 II]
 (a) 100 N (b) 90 N
 (c) 70 N (d) 75 N
21. An elevator in a building can carry a maximum of 10 persons, with the average mass of each person being 68 kg. The mass of the elevator itself is 920 kg and it moves with a constant speed of 3 m/s. The frictional force opposing the motion is 6000 N. If the elevator is moving up with its full capacity, the power delivered by the motor to the elevator ($g = 10 \text{ m/s}^2$) must be at least: [7 Jan. 2020 II]
 (a) 56300 W (b) 62360 W
 (c) 48000 W (d) 66000 W
22. A mass of 10 kg is suspended vertically by a rope from the roof. When a horizontal force is applied on the rope at some point, the rope deviated at an angle of 45° at the roof point. If the suspended mass is at equilibrium, the magnitude of the force applied is ($g = 10 \text{ ms}^{-2}$) [9 Jan. 2019 II]
 (a) 200 N (b) 140 N
 (c) 70 N (d) 100 N
23. A mass 'm' is supported by a massless string wound around a uniform hollow cylinder of mass m and radius R. If the string does not slip on the cylinder, with what acceleration will the mass fall or release? [2014]

- (a) $\frac{2g}{3}$
 (b) $\frac{g}{2}$
 (c) $\frac{5g}{6}$
 (d) g

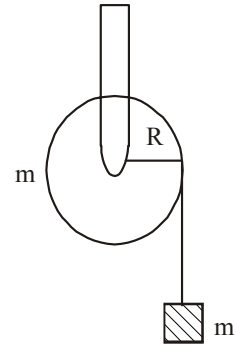

24. Two blocks of mass $M_1 = 20 \text{ kg}$ and $M_2 = 12 \text{ kg}$ are connected by a metal rod of mass 8 kg. The system is pulled vertically up by applying a force of 480 N as shown. The tension at the mid-point of the rod is:

[Online April 22, 2013]

- (a) 144 N
 (b) 96 N
 (c) 240 N
 (d) 192 N

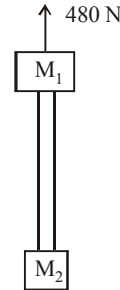

25. A uniform sphere of weight W and radius 5 cm is being held by a string as shown in the figure. The tension in the string will be: [Online April 9, 2013]

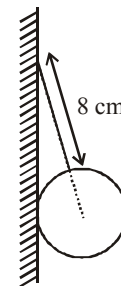

- (a) $12\frac{W}{5}$ (b) $5\frac{W}{12}$ (c) $13\frac{W}{5}$ (d) $13\frac{W}{12}$

26. A spring is compressed between two blocks of masses m_1 and m_2 placed on a horizontal frictionless surface as shown in the figure. When the blocks are released, they have initial velocity of v_1 and v_2 as shown. The blocks travel distances x_1 and x_2 respectively before coming to rest.

The ratio $\left(\frac{x_1}{x_2}\right)$ is [Online May 12, 2012]

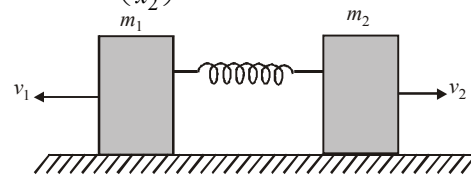

- (a) $\frac{m_2}{m_1}$ (b) $\frac{m_1}{m_2}$ (c) $\sqrt{\frac{m_2}{m_1}}$ (d) $\sqrt{\frac{m_1}{m_2}}$



27. A block of mass m is connected to another block of mass M by a spring (massless) of spring constant k . The blocks are kept on a smooth horizontal plane. Initially the blocks are at rest and the spring is unstretched. Then a constant force F starts acting on the block of mass M to pull it. Find the force of the block of mass m . [2007]

- (a) $\frac{MF}{(m+M)}$ (b) $\frac{mF}{M}$
 (c) $\frac{(M+m)F}{m}$ (d) $\frac{mF}{(m+M)}$

28. Two masses $m_1 = 5\text{g}$ and $m_2 = 4.8\text{kg}$ tied to a string are hanging over a light frictionless pulley. What is the acceleration of the masses when left free to move? ($g = 9.8\text{m/s}^2$) [2004]

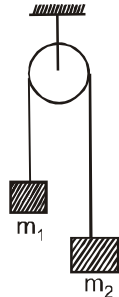

- (a) 5 m/s^2 (b) 9.8 m/s^2
 (c) 0.2 m/s^2 (d) 4.8 m/s^2

29. A spring balance is attached to the ceiling of a lift. A man hangs his bag on the spring and the spring reads 49 N , when the lift is stationary. If the lift moves downward with an acceleration of 5 m/s^2 , the reading of the spring balance will be [2003]

- (a) 24 N (b) 74 N (c) 15 N (d) 49 N

30. A block of mass M is pulled along a horizontal frictionless surface by a rope of mass m . If a force P is applied at the free end of the rope, the force exerted by the rope on the block is [2003]

- (a) $\frac{Pm}{M+m}$ (b) $\frac{Pm}{M-m}$ (c) P (d) $\frac{PM}{M+m}$

31. A light spring balance hangs from the hook of the other light spring balance and a block of mass $M\text{ kg}$ hangs from the former one. Then the true statement about the scale reading is [2003]

- (a) both the scales read $M\text{ kg}$ each
 (b) the scale of the lower one reads $M\text{ kg}$ and of the upper one zero
 (c) the reading of the two scales can be anything but the sum of the reading will be $M\text{ kg}$
 (d) both the scales read $M/2\text{ kg}$ each

32. A lift is moving down with acceleration a . A man in the lift drops a ball inside the lift. The acceleration of the ball as observed by the man in the lift and a man standing stationary on the ground are respectively [2002]

- (a) g, g (b) $g - a, g - a$
 (c) $g - a, g$ (d) a, g

33. When forces F_1, F_2, F_3 are acting on a particle of mass m such that F_2 and F_3 are mutually perpendicular, then the particle remains stationary. If the force F_1 is now removed then the acceleration of the particle is [2002]

- (a) F_1/m (b) F_2F_3/mF_1
 (c) $(F_2 - F_3)/m$ (d) F_2/m

34. Two forces are such that the sum of their magnitudes is 18 N and their resultant is 12 N which is perpendicular to the smaller force. Then the magnitudes of the forces are [2002]

- (a) $12\text{ N}, 6\text{ N}$ (b) $13\text{ N}, 5\text{ N}$
 (c) $10\text{ N}, 8\text{ N}$ (d) $16\text{ N}, 2\text{ N}$

35. A light string passing over a smooth light pulley connects two blocks of masses m_1 and m_2 (vertically). If the acceleration of the system is $g/8$, then the ratio of the masses is [2002]

- (a) $8:1$ (b) $9:7$ (c) $4:3$ (d) $5:3$

36. Three identical blocks of masses $m = 2\text{ kg}$ are drawn by a force $F = 10.2\text{ N}$ with an acceleration of 0.6 ms^{-2} on a frictionless surface, then what is the tension (in N) in the string between the blocks B and C ? [2002]

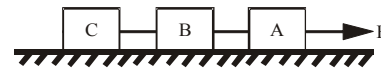

- (a) 9.2 (b) 3.4 (c) 4 (d) 9.8

37. One end of a massless rope, which passes over a massless and frictionless pulley P is tied to a hook C while the other end is free. Maximum tension that the rope can bear is 360 N . With what value of maximum safe acceleration (in ms^{-2}) can a man of 60 kg climb on the rope? [2002]

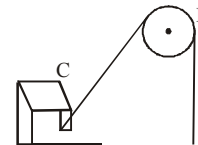

- (a) 16 (b) 6 (c) 4 (d) 8

TOPIC 3 Friction



38. An insect is at the bottom of a hemispherical ditch of radius 1 m . It crawls up the ditch but starts slipping after it is at height h from the bottom. If the coefficient of friction between the ground and the insect is 0.75 , then h is : ($g = 10\text{ ms}^{-2}$) [Sep. 06, 2020 (I)]

- (a) 0.20 m (b) 0.45 m
 (c) 0.60 m (d) 0.80 m

39. A block starts moving up an inclined plane of inclination 30° with an initial velocity of v_0 . It comes back to its initial position with velocity $\frac{v_0}{2}$. The value of the coefficient of kinetic friction between the block and the inclined plane is close to $\frac{I}{1000}$. The nearest integer to I is _____.

[NA Sep. 03, 2020 (II)]

40. A block of mass 5 kg is (i) pushed in case (A) and (ii) pulled in case (B), by a force $F=20$ N, making an angle of 30° with the horizontal, as shown in the figures. The coefficient of friction between the block and floor is $\mu = 0.2$. The difference between the accelerations of the block, in case (B) and case (A) will be : ($g=10 \text{ ms}^{-2}$)

[12 April 2019 II]

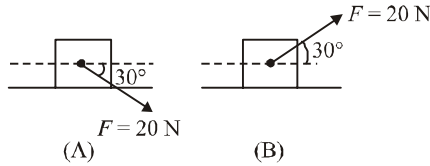

- (a) 0.4 ms^{-2} (b) 3.2 ms^{-2}
 (c) 0.8 ms^{-2} (d) 0 ms^{-2}
41. Two blocks A and B masses $m_A=1$ kg and $m_B=3$ kg are kept on the table as shown in figure. The coefficient of friction between A and B is 0.2 and between B and the surface of the table is also 0.2. The maximum force F that can be applied on B horizontally, so that the block A does not slide over the block B is : [Take $g = 10 \text{ m/s}^2$]

[10 April 2019 II]

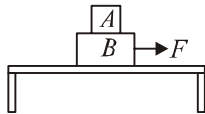

- (a) 8 N (b) 16 N (c) 40 N (d) 12 N
42. A block kept on a rough inclined plane, as shown in the figure, remains at rest upto a maximum force 2 N down the inclined plane. The maximum external force up the inclined plane that does not move the block is 10 N. The coefficient of static friction between the block and the plane is : [Take $g = 10 \text{ m/s}^2$]

[12 Jan. 2019 II]

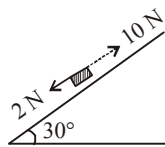

- (a) $\frac{\sqrt{3}}{2}$ (b) $\frac{\sqrt{3}}{4}$
 (c) $\frac{1}{2}$ (d) $\frac{2}{3}$
43. A block of mass 10 kg is kept on a rough inclined plane as shown in the figure. A force of 3 N is applied on the block. The coefficient of static friction between the plane and the block is 0.6. What should be the minimum value of force P , such that the block doesnot move downward? (take $g = 10 \text{ ms}^{-2}$)

[9 Jan. 2019 I]

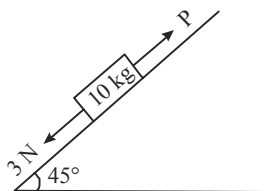

- (a) 32 N (b) 18 N (c) 23 N (d) 25 N

44. Two masses $m_1 = 5$ kg and $m_2 = 10$ kg, connected by an inextensible string over a frictionless pulley, are moving as shown in the figure. The coefficient of friction of horizontal surface is 0.15. The minimum weight m that should be put on top of m_2 to stop the motion is: [2018]

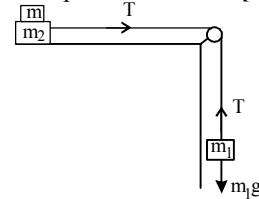

- (a) 18.3 kg (b) 27.3 kg
 (c) 43.3 kg (d) 10.3 kg
45. A given object takes n times more time to slide down a 45° rough inclined plane as it takes to slide down a perfectly smooth 45° incline. The coefficient of kinetic friction between the object and the incline is :

[Online April 15, 2018]

- (a) $\sqrt{1-\frac{1}{n^2}}$ (b) $1-\frac{1}{n^2}$
 (c) $\frac{1}{2-n^2}$ (d) $\sqrt{\frac{1}{1-n^2}}$

46. A body of mass 2kg slides down with an acceleration of 3 m/s^2 on a rough inclined plane having a slope of 30° . The external force required to take the same body up the plane with the same acceleration will be: ($g = 10 \text{ m/s}^2$)

[Online April 15, 2018]

- (a) 4N (b) 14N (c) 6N (d) 20N
47. A rocket is fired vertically from the earth with an acceleration of $2g$, where g is the gravitational acceleration. On an inclined plane inside the rocket, making an angle θ with the horizontal, a point object of mass m is kept. The minimum coefficient of friction μ_{\min} between the mass and the inclined surface such that the mass does not move is :

[Online April 9, 2016]

- (a) $\tan 2\theta$ (b) $\tan \theta$
 (c) $3 \tan \theta$ (d) $2 \tan \theta$
48. Given in the figure are two blocks A and B of weight 20 N and 100 N, respectively. These are being pressed against a wall by a force F as shown. If the coefficient of friction between the blocks is 0.1 and between block B and the wall is 0.15, the frictional force applied by the wall on block B is: [2015]

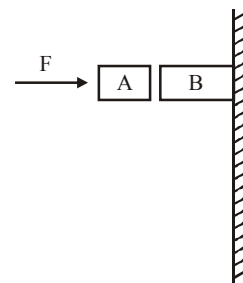

- (a) 120 N (b) 150 N
 (c) 100 N (d) 80 N

49. A block of mass $m = 10 \text{ kg}$ rests on a horizontal table. The coefficient of friction between the block and the table is 0.05. When hit by a bullet of mass 50 g moving with speed v , that gets embedded in it, the block moves and comes to stop after moving a distance of 2 m on the table. If a freely falling object were to acquire speed $\frac{v}{10}$ after being dropped from height H , then neglecting energy losses and taking $g = 10 \text{ ms}^{-2}$, the value of H is close to:

- [Online April 10, 2015]
 (a) 0.05 km (b) 0.02 km
 (c) 0.03 km (d) 0.04 km

50. A block of mass m is placed on a surface with a vertical cross section given by $y = \frac{x^3}{6}$. If the coefficient of friction is 0.5, the maximum height above the ground at which the block can be placed without slipping is: [2014]

- (a) $\frac{1}{6}m$ (b) $\frac{2}{3}m$ (c) $\frac{1}{3}m$ (d) $\frac{1}{2}m$

51. Consider a cylinder of mass M resting on a rough horizontal rug that is pulled out from under it with acceleration 'a' perpendicular to the axis of the cylinder. What is F_{friction} at point P? It is assumed that the cylinder does not slip.

[Online April 19, 2014]

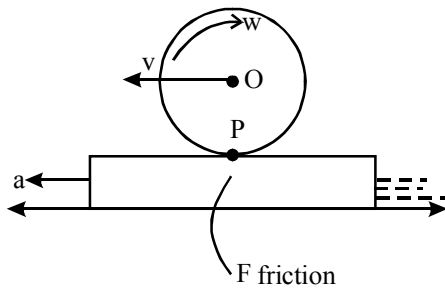

- (a) Mg (b) Ma (c) $\frac{Ma}{2}$ (d) $\frac{Ma}{3}$

52. A heavy box is to be dragged along a rough horizontal floor. To do so, person A pushes it at an angle 30° from the horizontal and requires a minimum force F_A , while person B pulls the box at an angle 60° from the horizontal and needs minimum force F_B . If the coefficient of friction

between the box and the floor is $\frac{\sqrt{3}}{5}$, the ratio $\frac{F_A}{F_B}$ is

[Online April 19, 2014]

- (a) $\sqrt{3}$ (b) $\frac{5}{\sqrt{3}}$
 (c) $\frac{\sqrt{3}}{2}$ (d) $\frac{2}{\sqrt{3}}$

53. A small ball of mass m starts at a point A with speed v_0 and moves along a frictionless track AB as shown. The track BC has coefficient of friction μ . The ball comes to stop at C after travelling a distance L which is:

[Online April 11, 2014]

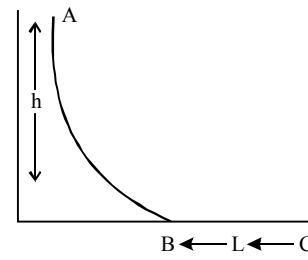

- (a) $\frac{2h}{\mu} + \frac{v_0^2}{2\mu g}$ (b) $\frac{h}{\mu} + \frac{v_0^2}{2\mu g}$
 (c) $\frac{h}{2\mu} + \frac{v_0^2}{\mu g}$ (d) $\frac{h}{2\mu} + \frac{v_0^2}{2\mu g}$

54. A block A of mass 4 kg is placed on another block B of mass 5 kg, and the block B rests on a smooth horizontal table. If the minimum force that can be applied on A so that both the blocks move together is 12 N, the maximum force that can be applied to B for the blocks to move together will be: [Online April 9, 2014]

- (a) 30 N (b) 25 N (c) 27 N (d) 48 N

55. A block is placed on a rough horizontal plane. A time dependent horizontal force $F = kt$ acts on the block, where k is a positive constant. The acceleration - time graph of the block is:

[Online April 25, 2013]

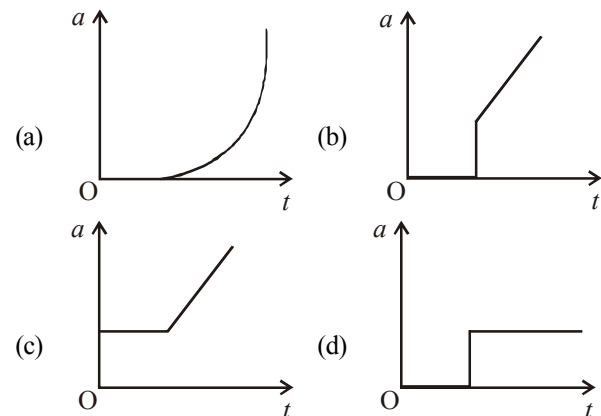

56. A body starts from rest on a long inclined plane of slope 45° . The coefficient of friction between the body and the plane varies as $\mu = 0.3x$, where x is distance travelled down the plane. The body will have maximum speed (for $g = 10 \text{ m/s}^2$) when $x =$ [Online April 22, 2013]

- (a) 9.8 m (b) 27 m (c) 12 m (d) 3.33 m

57. A block of weight W rests on a horizontal floor with coefficient of static friction μ . It is desired to make the block move by applying minimum amount of force. The angle θ from the horizontal at which the force should be applied and magnitude of the force F are respectively.

[Online May 19, 2012]

- (a) $\theta = \tan^{-1}(\mu), F = \frac{\mu W}{\sqrt{1+\mu^2}}$
 (b) $\theta = \tan^{-1}\left(\frac{1}{\mu}\right), F = \frac{\mu W}{\sqrt{1+\mu^2}}$

(c) $\theta = 0, F = \mu W$

(d) $\theta = \tan^{-1}\left(\frac{\mu}{1+\mu}\right), F = \frac{\mu W}{1+\mu}$

58. An insect crawls up a hemispherical surface very slowly. The coefficient of friction between the insect and the surface is $1/3$. If the line joining the centre of the hemispherical surface to the insect makes an angle α with the vertical, the maximum possible value of α so that the insect does not slip is given by **[Online May 12, 2012]**

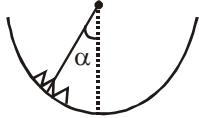

- (a) $\cot \alpha = 3$ (b) $\sec \alpha = 3$
 (c) $\operatorname{cosec} \alpha = 3$ (d) $\cos \alpha = 3$

59. The minimum force required to start pushing a body up rough (frictional coefficient μ) inclined plane is F_1 while the minimum force needed to prevent it from sliding down is F_2 . If the inclined plane makes an angle θ from the

horizontal such that $\tan \theta = 2\mu$ then the ratio $\frac{F_1}{F_2}$ is

- (a) 1 (b) 2 (c) 3 (d) 4 **[2011 RS]**

60. If a spring of stiffness ' k ' is cut into parts ' A ' and ' B ' of length $\ell_A : \ell_B = 2 : 3$, then the stiffness of spring ' A ' is given by **[2011 RS]**

- (a) $\frac{3k}{5}$ (b) $\frac{2k}{5}$
 (c) k (d) $\frac{5k}{2}$

61. A smooth block is released at rest on a 45° incline and then slides a distance ' d '. The time taken to slide is ' n ' times as much to slide on rough incline than on a smooth incline. The coefficient of friction is **[2005]**

- (a) $\mu_k = \sqrt{1 - \frac{1}{n^2}}$ (b) $\mu_k = 1 - \frac{1}{n^2}$
 (c) $\mu_s = \sqrt{1 - \frac{1}{n^2}}$ (d) $\mu_s = 1 - \frac{1}{n^2}$

62. The upper half of an inclined plane with inclination ϕ is perfectly smooth while the lower half is rough. A body starting from rest at the top will again come to rest at the bottom if the coefficient of friction for the lower half is given by **[2005]**

- (a) $2 \cos \phi$ (b) $2 \sin \phi$ (c) $\tan \phi$ (d) $2 \tan \phi$

63. Consider a car moving on a straight road with a speed of 100 m/s . The distance at which car can be stopped is **[2005]**

- (a) 1000 m (b) 800 m (c) 400 m (d) 100 m

64. A block rests on a rough inclined plane making an angle of 30° with the horizontal. The coefficient of static friction between the block and the plane is 0.8 . If the frictional force on the block is 10 N , the mass of the block (in kg) is (take $g = 10 \text{ m/s}^2$) **[2004]**

- (a) 1.6 (b) 4.0 (c) 2.0 (d) 2.5

65. A horizontal force of 10 N is necessary to just hold a block stationary against a wall. The coefficient of friction between the block and the wall is 0.2 . The weight of the block is **[2003]**

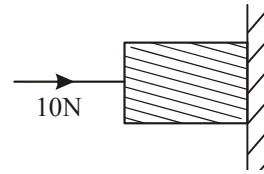

- (a) 20 N (b) 50 N (c) 100 N (d) 2 N

66. A marble block of mass 2 kg lying on ice when given a velocity of 6 m/s is stopped by friction in 10 s . Then the coefficient of friction is **[2003]**

- (a) 0.02 (b) 0.03 (c) 0.04 (d) 0.06

TOPIC 4 Circular Motion, Banking of Road



67. A disc rotates about its axis of symmetry in a horizontal plane at a steady rate of 3.5 revolutions per second. A coin placed at a distance of 1.25 cm from the axis of rotation remains at rest on the disc. The coefficient of friction between the coin and the disc is ($g = 10 \text{ m/s}^2$) **[Online April 15, 2018]**

- (a) 0.5 (b) 0.7 (c) 0.3 (d) 0.6

68. A conical pendulum of length 1 m makes an angle $\theta = 45^\circ$ w.r.t. Z-axis and moves in a circle in the XY plane. The radius of the circle is 0.4 m and its centre is vertically below O. The speed of the pendulum, in its circular path, will be :

(Take $g = 10 \text{ ms}^{-2}$) **[Online April 9, 2017]**

- (a) 0.4 m/s
 (b) 4 m/s
 (c) 0.2 m/s
 (d) 2 m/s

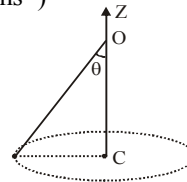

69. A particle is released on a vertical smooth semicircular track from point X so that OX makes angle θ from the vertical (see figure). The normal reaction of the track on the particle vanishes at point Y where OY makes angle ϕ with the horizontal. Then: **[Online April 19, 2014]**

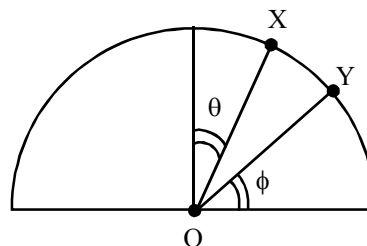

- (a) $\sin \phi = \cos \phi$ (b) $\sin \phi = \frac{1}{2} \cos \theta$
 (c) $\sin \phi = \frac{2}{3} \cos \theta$ (d) $\sin \phi = \frac{3}{4} \cos \theta$

70. A body of mass 'm' is tied to one end of a spring and whirled round in a horizontal plane with a constant angular velocity. The elongation in the spring is 1 cm. If the angular velocity is doubled, the elongation in the spring is 5 cm. The original length of the spring is :

[Online April 23, 2013]

- (a) 15 cm (b) 12 cm
 (c) 16 cm (d) 10 cm
71. A point P moves in counter-clockwise direction on a circular path as shown in the figure. The movement of 'P' is such that it sweeps out a length $s = t^3 + 5$, where s is in metres and t is in seconds. The radius of the path is 20 m. The acceleration of 'P' when $t = 2$ s is nearly. [2010]

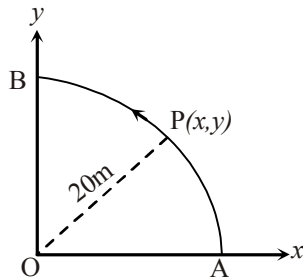

- (a) 13m/s^2 (b) 12m/s^2
 (c) 7.2ms^2 (d) 14m/s^2
72. For a particle in uniform circular motion, the acceleration \vec{a} at a point P(R,θ) on the circle of radius R is (Here θ is measured from the x-axis) [2010]

- (a) $-\frac{v^2}{R} \cos \theta \hat{i} + \frac{v^2}{R} \sin \theta \hat{j}$
 (b) $-\frac{v^2}{R} \sin \theta \hat{i} + \frac{v^2}{R} \cos \theta \hat{j}$
 (c) $-\frac{v^2}{R} \cos \theta \hat{i} - \frac{v^2}{R} \sin \theta \hat{j}$
 (d) $\frac{v^2}{R} \hat{i} + \frac{v^2}{R} \hat{j}$

73. An annular ring with inner and outer radii R_1 and R_2 is rolling without slipping with a uniform angular speed. The ratio of the forces experienced by the two particles situated on the inner and outer parts of the ring, $\frac{F_1}{F_2}$ is [2005]

- (a) $\left(\frac{R_1}{R_2}\right)^2$ (b) $\frac{R_2}{R_1}$
 (c) $\frac{R_1}{R_2}$ (d) 1

74. Which of the following statements is FALSE for a particle moving in a circle with a constant angular speed ? [2004]

- (a) The acceleration vector points to the centre of the circle
 (b) The acceleration vector is tangent to the circle
 (c) The velocity vector is tangent to the circle
 (d) The velocity and acceleration vectors are perpendicular to each other.

75. The minimum velocity (in ms^{-1}) with which a car driver must traverse a flat curve of radius 150 m and coefficient of friction 0.6 to avoid skidding is [2002]

- (a) 60 (b) 30
 (c) 15 (d) 25



Hints & Solutions



1. (a) Given

$$\vec{F} = k(v_y \hat{i} + v_x \hat{j})$$

$$\therefore F_x = kv_y \hat{i}, F_y = kv_x \hat{j}$$

$$\frac{mdv_x}{dt} = kv_y \Rightarrow \frac{dv_x}{dt} = \frac{k}{m} v_y$$

Similarly, $\frac{dv_y}{dt} = \frac{k}{m} v_x$

$$\frac{dv_y}{dv_x} = \frac{v_x}{v_y} \Rightarrow \int v_y dv_y = \int v_x dv_x$$

$$v_y^2 = v_x^2 + C$$

$$v_y^2 - v_x^2 = \text{constant}$$

$$\vec{v} \times \vec{a} = (v_x \hat{i} + v_y \hat{j}) \times \frac{k}{m} (v_y \hat{i} + v_x \hat{j})$$

$$= (v_x^2 \hat{k} - v_y^2 \hat{k}) \frac{k}{m} = (v_x^2 - v_y^2) \frac{k}{m} \hat{k} = \text{constant}$$

2. (b) From the Newton's second law,

$$F = \frac{dp}{dt} = \frac{d(mv)}{dt} = v \left(\frac{dm}{dt} \right) \quad \dots(i)$$

We have given, $\frac{dM(t)}{dt} = bv^2(t) \quad \dots(ii)$

Thrust on the satellite,

$$F = -v \left(\frac{dm}{dt} \right) = -v(bv^2) = -bv^3 \quad [\text{Using (i) and (ii)}]$$

$$\Rightarrow F = M(t)a = -bv^3 \Rightarrow a = \frac{-bv^3}{M(t)}$$

3. (d)

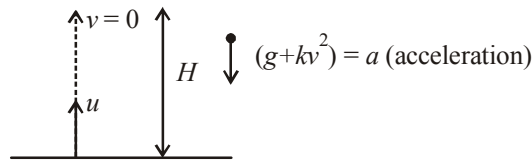

$$\vec{F} = mkv^2 - mg \quad (\because mg \text{ and } mkv^2 \text{ act opposite to each other})$$

$$\vec{a} = \frac{\vec{F}}{m} = -[kv^2 + g]$$

$$\Rightarrow v \cdot \frac{dv}{dh} = -[kv^2 + g] \quad \left(\because a = v \frac{dv}{dh} \right)$$

$$\Rightarrow \int_u^h \frac{v \cdot dv}{kv^2 + g} = \int_0^h dh$$

$$\Rightarrow \frac{1}{2k} \ln [kv^2 + g]_u^h = -h$$

$$\Rightarrow \frac{1}{2k} \ln \left[\frac{ku^2 + g}{g} \right] = h$$

4. (a) Net acceleration

$$\frac{dv}{dt} = a = -(g + \gamma v^2)$$

Let time t required to rise to its zenith (v = 0) so,

$$\int_{v_0}^0 \frac{-dv}{g + \gamma v^2} = \int_0^t dt \quad [\text{for } H_{\text{max}}, v = 0]$$

$$\therefore t = \frac{1}{\sqrt{\gamma g}} \tan^{-1} \left(\frac{\sqrt{\gamma} v_0}{\sqrt{g}} \right)$$

5. (d) $v^2 = u^2 - 2gh$

$$\text{or } v = \sqrt{u^2 - 2gh}$$

$$\text{Momentum, } P = mv = m\sqrt{u^2 - 2gh}$$

At $h = 0$, $P = mu$ and at $h = \frac{u^2}{g}$, $P = 0$

upward direction is positive and downward direction is negative.

6. (b) From Newton's second law

$$\frac{dp}{dt} = F = kt$$

Integrating both sides we get,

$$\int_p^{3p} dp = \int_0^T kt dt \Rightarrow [p]_p^{3p} = k \left[\frac{t^2}{2} \right]_0^T$$

$$\Rightarrow 2p = \frac{kT^2}{2} \Rightarrow T = 2\sqrt{\frac{p}{k}}$$

7. (a) From $F = \frac{R}{t^2} v(t) \Rightarrow m \frac{dv}{dt} = \frac{R}{t^2} v(t)$

Integrating both sides $\int \frac{dv}{v} = \int \frac{R dt}{mt^2}$

$$\ln v = -\frac{R}{mt}$$

$$\therefore \ln v \propto \frac{1}{t}$$

8. (b) Space between the supports for motion of beads is $L - 2nr$

Average force experienced by each support,

$$F = \frac{2mV}{2(L - 2nr)} = \frac{mV^2}{L - 2nr}$$

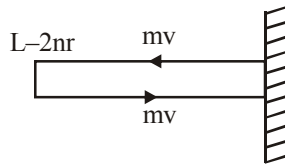

9. (a) From question,
 Mass of body, $m = 5 \text{ kg}$
 Velocity at $t = 0$,
 $u = (6\hat{i} - 2\hat{j}) \text{ m/s}$
 Velocity at $t = 10 \text{ s}$,
 $v = +6\hat{j} \text{ m/s}$
 Force, $F = ?$
 Acceleration, $a = \frac{v-u}{t}$
 $= \frac{6\hat{j} - (6\hat{i} - 2\hat{j})}{10} = \frac{-3\hat{i} + 4\hat{j}}{5} \text{ m/s}^2$
 Force, $F = ma$
 $= 5 \times \frac{(-3\hat{i} + 4\hat{j})}{5} = (-3\hat{i} + 4\hat{j}) \text{ N}$

10. (c) Given that $F(t) = F_0 e^{-bt}$
 $\Rightarrow m \frac{dv}{dt} = F_0 e^{-bt}$
 $\frac{dv}{dt} = \frac{F_0}{m} e^{-bt}$
 $\int_0^v dv = \frac{F_0}{m} \int_0^t e^{-bt} dt$
 $v = \frac{F_0}{m} \left[\frac{e^{-bt}}{-b} \right]_0^t = \frac{F_0}{mb} [-e^{-bt} - e^{-0}]$
 $\Rightarrow v = \frac{F_0}{mb} [1 - e^{-bt}]$

11. (a) According to Newton's third law of motion i.e. every action is associated with equal and opposite reaction.

12. (d) $mg \sin \theta = ma$
 $\therefore a = g \sin \theta$
 \therefore Vertical component of acceleration
 $= g \sin^2 \theta$
 \therefore Relative vertical acceleration of A with respect to B is
 $g(\sin^2 60 - \sin^2 30)$

$$= g \left(\frac{3}{4} - \frac{1}{4} \right) = \frac{g}{2} = 4.9 \text{ m/s}^2$$

in vertical direction

13. (d) For the motion of ball, just after the throwing
 $v = 0$, $s = 2 \text{ m}$, $a = -g = -10 \text{ m/s}^2$
 $v^2 - u^2 = 2as$ for upward journey
 $\Rightarrow -u^2 = 2(-10) \times 2 \Rightarrow u^2 = 40$
 When the ball is in the hands of the thrower
 $u = 0$, $v = \sqrt{40} \text{ m/s}^{-1}$
 $s = 0.2 \text{ m}$
 $v^2 - u^2 = 2as$

$$\Rightarrow 40 - 0 = 2(a) 0.2 \Rightarrow a = 100 \text{ m/s}^2$$

$$\therefore F = ma = 0.2 \times 100 = 20 \text{ N}$$

$$\Rightarrow N - mg = 20 \Rightarrow N = 20 + 2 = 22 \text{ N}$$

Note :

$$W_{hand} + W_{gravity} = \Delta K$$

$$\Rightarrow F(0.2) + (0.2)(10)(2.2) = 0 \Rightarrow F = 22 \text{ N}$$

14. (c) Given, mass of cricket ball, $m = 150 \text{ g} = 0.15 \text{ kg}$
 Initial velocity, $u = 20 \text{ m/s}$
 Force,

$$F = \frac{m(v-u)}{t} = \frac{0.15(0-20)}{0.1} = 30 \text{ N}$$

15. (c) Mass (m) = 0.3 kg

$$\text{Force, } F = m \cdot a = -kx$$

$$\Rightarrow ma = -15x$$

$$\Rightarrow 0.3a = -15x$$

$$\Rightarrow a = -\frac{15}{0.3}x = -\frac{150}{3}x = -50x$$

$$a = -50 \times 0.2 = 10 \text{ m/s}^2$$

16. (c) When the incline is given an acceleration a towards the right, the block receives a reaction ma towards left.

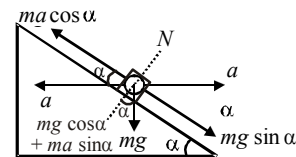

For block to remain stationary, Net force along the incline should be zero.

$$mg \sin \alpha = ma \cos \alpha \Rightarrow a = g \tan \alpha$$

17. (b) In the absence of air resistance, if the rocket moves up with an acceleration a , then thrust

$$F = mg + ma$$

$$\therefore F = m(g + a) = 3.5 \times 10^4 (10 + 10)$$

$$= 7 \times 10^5 \text{ N}$$

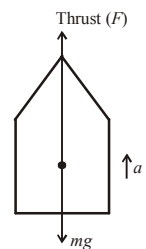

18. (d) Resultant force is zero, as three forces are represented by the sides of a triangle taken in the same order. From Newton's second law, $\vec{F}_{net} = m\vec{a}$.

Therefore, acceleration is also zero i.e., velocity remains unchanged.

19. (d) This is a case of sliding (if plane is frictionless) and therefore the acceleration of all the bodies is same.

20. (a) From the free body diagram

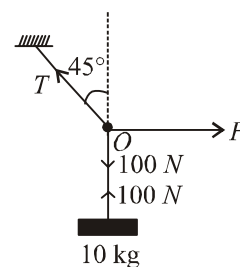

$$T \cos 45^\circ = 100 \text{ N} \quad \dots(i)$$

$$T \sin 45^\circ = F \quad \dots(ii)$$

On dividing (i) by (ii) we get

$$\frac{T \cos 45^\circ}{T \sin 45^\circ} = \frac{100}{F}$$

$$\Rightarrow F = 100 \text{ N}$$

21. (d) Net force on the elevator = force on elevator + frictional force

$$\Rightarrow F = (10m + M)g + f$$

where, m = mass of person, M = mass of elevator, f = frictional force

$$\Rightarrow F = (10 \times 68 + 920) \times 9.8 + 600$$

$$\Rightarrow F = 22000 \text{ N}$$

$$\Rightarrow P = FV = 22000 \times 3 = 66000 \text{ W}$$

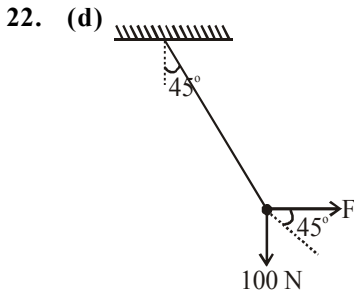

At equilibrium,

$$\tan 45^\circ = \frac{mg}{F} = \frac{100}{F}$$

$$\therefore F = 100 \text{ N}$$

23. (b) From figure,

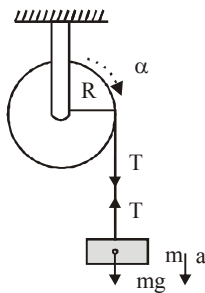

$$\text{Acceleration } a = R\alpha$$

$$\text{and } mg - T = ma$$

From equation (i) and (ii)

$$T \times R = mR^2\alpha = mR^2\left(\frac{a}{R}\right)$$

$$\text{or } T = ma$$

$$\Rightarrow mg - ma = ma$$

$$\Rightarrow a = \frac{g}{2}$$

24. (d) Acceleration produced in upward direction

$$a = \frac{F}{M_1 + M_2 + \text{Mass of metal rod}}$$

$$= \frac{480}{20 + 12 + 8} = 12 \text{ ms}^{-2}$$

Tension at the mid point

$$T = \left(M_2 + \frac{\text{Mass of rod}}{2} \right) a$$

$$= (12 + 4) \times 12 = 192 \text{ N}$$

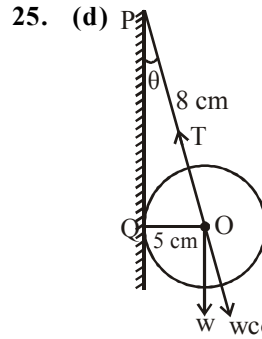

$$PQ = \sqrt{OP^2 + OQ^2}$$

$$= \sqrt{13^2 + 5^2} = 12$$

Tension in the string

$$T = w \cos \theta = \frac{13}{12} W$$

26. (a)

27. (d) Writing free body-diagrams for m & M ,

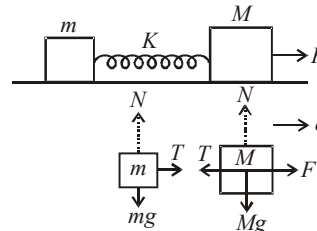

we get $T = ma$ and $F - T = Ma$

where T is force due to spring

$$\Rightarrow F - ma = Ma \text{ or, } F = Ma + ma$$

\therefore Acceleration of the system

$$a = \frac{F}{M + m}$$

Now, force acting on the block of mass m is

$$ma = m \left(\frac{F}{M + m} \right) = \frac{mF}{m + M}$$

If a is the acceleration along the inclined plane, then

28. (c) Here, $m_1 = 5 \text{ kg}$ and $m_2 = 4.8 \text{ kg}$.

If a is the acceleration of the masses,

$$m_1 a = m_1 g - T \quad \dots(i)$$

$$m_2 a = T - m_2 g \quad \dots(ii)$$

Solving (i) and (ii) we get

$$a = \left(\frac{m_1 - m_2}{m_1 + m_2} \right) g$$

$$\Rightarrow a = \frac{(5 - 4.8) \times 9.8}{(5 + 4.8)} \text{ m/s}^2 = 0.2 \text{ m/s}^2$$

29. (a) When lift is stationary, $W_1 = mg$... (i)
 When the lift descends with acceleration, a
 $W_2 = m(g - a)$
 $W_2 = \frac{49}{10}(10 - 5) = 24.5 \text{ N}$

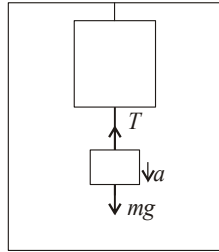

30. (d) Taking the rope and the block as a system

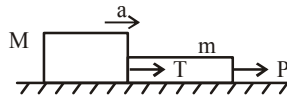

we get $P = (m + M)a$

$$\therefore \text{Acceleration produced, } a = \frac{P}{m + M}$$

Taking the block as a system,
 Force on the block, $F = Ma$

$$\therefore F = \frac{MP}{m + M}$$

31. (a) The Earth exerts a pulling force Mg . The block in turn exerts a reaction force Mg on the spring of spring balance S_1 which therefore shows a reading of $M \text{ kgf}$.
 As both the springs are massless. Therefore, it exerts a force of Mg on the spring of spring balance S_2 which shows the reading of $M \text{ kgf}$.

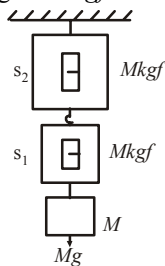

32. (c) **Case - I:** For the man standing in the lift, the acceleration of the ball

$$\vec{a}_{bm} = \vec{a}_b - \vec{a}_m \Rightarrow a_{bm} = g - a$$

Case - II: The man standing on the ground, the acceleration of the ball

$$\vec{a}_{bm} = \vec{a}_b - \vec{a}_m \Rightarrow a_{bm} = g - 0 = g$$

33. (a) When forces F_1, F_2 and F_3 are acting on the particle, it remains in equilibrium. Force F_2 and F_3 are perpendicular to each other,

$$F_1 = F_2 + F_3$$

$$\therefore F_1 = \sqrt{F_2^2 + F_3^2}$$

The force F_1 is now removed, so, resultant of F_2 and F_3 will now make the particle move with force equal to F_1 .

$$\text{Then, acceleration, } a = \frac{F_1}{m}$$

34. (b) Let the two forces be F_1 and F_2 and let $F_2 < F_1$. R is the resultant force.
 Given $F_1 + F_2 = 18$... (i)

$$\text{From the figure } F_2^2 + R^2 = F_1^2$$

$$F_1^2 - F_2^2 = R^2$$

$$\therefore F_1^2 - F_2^2 = 144$$
 ... (ii)

Only option (b) follows equation (i) and (ii).

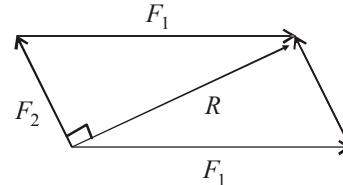

35. (b) For mass m_1
 $m_1g - T = m_1a$... (i)
 For mass m_2
 $T - m_2g = m_2a$... (ii)

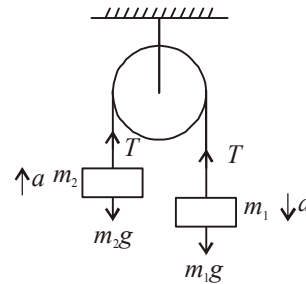

Adding the equations we get

$$a = \frac{(m_1 - m_2)g}{m_1 + m_2}$$

$$\text{Here } a = \frac{g}{8}$$

$$\therefore \frac{1}{8} = \frac{\frac{m_1}{m_2} - 1}{\frac{m_1}{m_2} + 1} \Rightarrow \frac{m_1}{m_2} + 1 = 8 \frac{m_1}{m_2} - 8 \Rightarrow \frac{m_1}{m_2} = \frac{9}{7}$$

36. (b) Force = mass \times acceleration

$$\therefore F = (m + m + m) \times a$$

$$F = 3m \times a$$

$$a = \frac{F}{3m}$$

$$\therefore a = \frac{10.2}{6} \text{ m/s}^2$$

$$\therefore T_2 = ma = 2 \times \frac{10.2}{6} = 3.4 \text{ N}$$

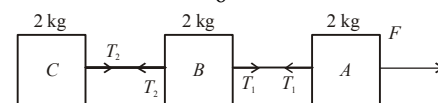

37. (c) Tension, $T = 360 \text{ N}$
 Mass of a man $m = 60 \text{ kg}$
 $mg - T = ma$

$$\therefore a = g - \frac{T}{m}$$

$$= 10 - \frac{360}{60} = 4 \text{ m/s}^2$$

38. (a) For balancing, $mg \sin \theta = f = \mu mg \cos \theta$

$$\Rightarrow \tan \theta = \mu = \frac{3}{4} = 0.75$$

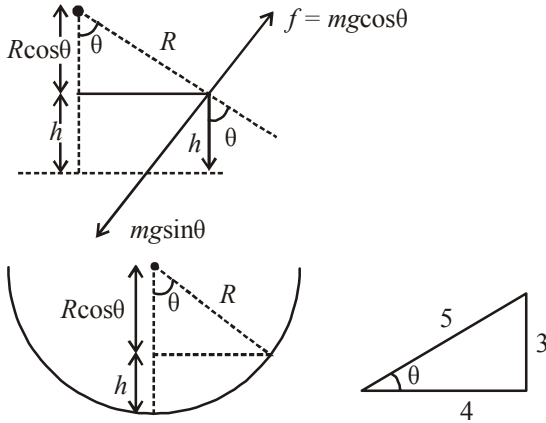

$$h = R - R \cos \theta = R - R \left(\frac{4}{5} \right) = \frac{R}{5}$$

$$\therefore h = \frac{R}{5} = 0.2 \text{ m} \quad [\because \text{radius, } R = 1 \text{ m}]$$

39. (346)

Acceleration of block while moving up an inclined plane,

$$a_1 = g \sin \theta + \mu g \cos \theta$$

$$\Rightarrow a_1 = g \sin 30^\circ + \mu g \cos 30^\circ$$

$$= \frac{g}{2} + \frac{\mu g \sqrt{3}}{2} \quad \dots(i) \quad (\because \theta = 30^\circ)$$

Using $v^2 - u^2 = 2a(s)$

$$\Rightarrow v_0^2 - 0^2 = 2a_1(s) \quad (\because u = 0)$$

$$\Rightarrow v_0^2 - 2a_1(s) = 0$$

$$\Rightarrow s = \frac{v_0^2}{a_1} \quad \dots(ii)$$

Acceleration while moving down an inclined plane

$$a_2 = g \sin \theta - \mu g \cos \theta$$

$$\Rightarrow a_2 = g \sin 30^\circ - \mu g \cos 30^\circ$$

$$\Rightarrow a_2 = \frac{g}{2} - \frac{\mu \sqrt{3}}{2} g \quad \dots(iii)$$

Using again $v^2 - u^2 = 2as$ for downward motion

$$\Rightarrow \left(\frac{v_0}{2} \right)^2 = 2a_2(s) \Rightarrow s = \frac{v_0^2}{4a_2} \quad \dots(iv)$$

Equating equation (ii) and (iv)

$$\frac{v_0^2}{a_1} = \frac{v_0^2}{4a_2} \Rightarrow a_1 = 4a_2$$

$$\Rightarrow \frac{g}{2} + \frac{\mu g \sqrt{3}}{2} = 4 \left(\frac{g}{2} - \frac{\mu \sqrt{3}}{2} \right)$$

$$\Rightarrow 5 + 5\sqrt{3}\mu = 4(5 - 5\sqrt{3}\mu) \quad (\text{Substituting, } g = 10 \text{ m/s}^2)$$

$$\Rightarrow 5 + 5\sqrt{3}\mu = 20 - 20\sqrt{3}\mu \Rightarrow 25\sqrt{3}\mu = 15$$

$$\Rightarrow \mu = \frac{\sqrt{3}}{5} = 0.346 = \frac{346}{1000}$$

$$\text{So, } \frac{I}{1000} = \frac{346}{1000}$$

40. (c) A : $N = 5g + 20 \sin 30^\circ$

$$= 50 + 20 \times \frac{1}{2} = 60 \text{ N}$$

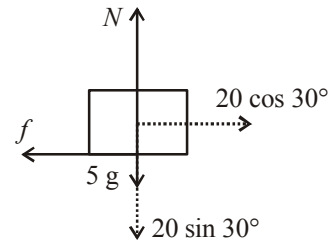

$$\text{Acceleration, } a_1 = \frac{F - f}{m} = \frac{20 \cos 30^\circ - \mu N}{5}$$

$$= \left[\frac{20 \times \frac{\sqrt{3}}{2} - 0.2 \times 60}{5} \right] = 1.06 \text{ m/s}^2$$

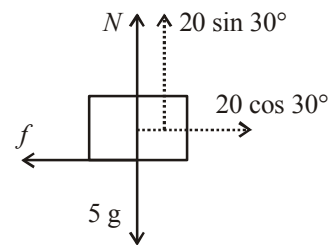

$$\text{B : } N = 5g - 20 \sin 30^\circ$$

$$= 50 - 20 \times \frac{1}{2} = 40 \text{ N}$$

$$a_2 = \frac{F - f}{m} = \left[\frac{20 \cos 30^\circ - 0.2 \times 40}{5} \right] = 1.86 \text{ m/s}^2$$

$$\text{Now } a_2 - a_1 = 1.86 - 1.06 = 0.8 \text{ m/s}^2$$

41. (b) Taking (A + B) as system

$$F - \mu(M + m)g$$

$$= (M + m)a$$

$$\Rightarrow a = \frac{F - \mu(M + m)g}{(M + m)}$$

$$a = \frac{F - (0.2)4 \times 10}{4} = \left(\frac{F - 8}{4} \right) \dots(i)$$

But, $a_{\max} = \mu g = 0.2 \times 10 = 2$

$$\therefore \frac{F-8}{4} = 2$$

$$\Rightarrow F = 16 \text{ N}$$

42. (a) From figure, $2 + mg \sin 30^\circ = \mu mg \cos 30^\circ$ and

$$10 = mg \sin 30^\circ + \mu mg \cos 30^\circ$$

$$= 2\mu mg \cos 30^\circ - 2$$

$$\Rightarrow 6 = \mu mg \cos 30^\circ \text{ and}$$

$$4 = mg \cos 30^\circ$$

By dividing above two

$$\Rightarrow \frac{3}{2} = \mu \times \sqrt{3}$$

$$\therefore \text{Coefficient of friction, } \mu = \frac{\sqrt{3}}{2}$$

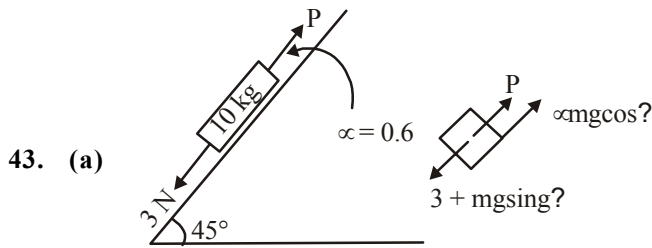

$$mg \sin 45^\circ = \frac{100}{\sqrt{2}} = 50\sqrt{2}$$

$$[\because m=10\text{kg}, g=9.8\text{m s}^{-2}]$$

$$\mu mg \cos \theta = 0.6 \times mg \times \frac{1}{\sqrt{2}} = 0.6 \cdot 50\sqrt{2}$$

$$3 + mg \sin \theta = P + \mu mg \cos \theta$$

$$3 + 50\sqrt{2} = P + 30\sqrt{2}$$

$$\therefore P = 31.28 = 32 \text{ N}$$

44. (b) Given : $m_1 = 5\text{kg}; m_2 = 10\text{kg}; \mu = 0.15$

FBD for $m_1, m_1 g - T = m_1 a$

$$\Rightarrow 50 - T = 5 \times a$$

$$\text{and, } T - 0.15(m+10)g = (10+m)a$$

For rest $a = 0$

$$\text{or, } 50 = 0.15(m+10)10$$

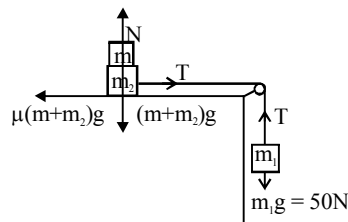

$$\Rightarrow 5 = \frac{3}{20}(m+10)$$

$$\frac{100}{3} = m+10 \therefore m = 23.3\text{kg; close to option (b)}$$

45. (b) The coefficients of kinetic friction between the object and the incline

$$\mu = \tan \theta \left(1 - \frac{1}{n^2}\right) \Rightarrow \mu = 1 - \frac{1}{n^2} \quad (\because \theta = 45^\circ)$$

46. (d) Equation of motion when the mass slides down

$$Mg \sin \theta - f = Ma$$

$$\Rightarrow 10 - f = 6 \quad (M = 2 \text{ kg}, a = 3 \text{ m/s}^2, \theta = 30^\circ \text{ given})$$

$$\therefore f = 4 \text{ N}$$

Equation of motion when the block is pushed up

Let the external force required to take the block up the plane with same acceleration be F

$$F - Mg \sin \theta - f = Ma$$

$$\Rightarrow F - 10 - 4 = 6$$

$$F = 20 \text{ N}$$

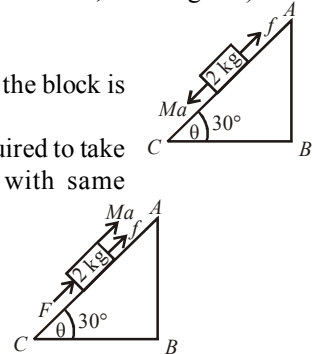

47. (b) Let μ be the minimum coefficient of friction

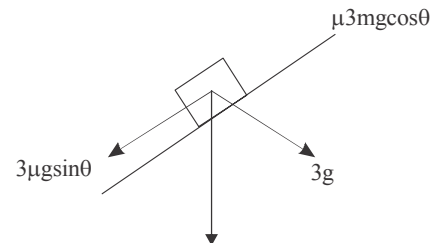

At equilibrium, mass does not move so,

$$3mg \sin \theta = \mu 3mg \cos \theta$$

$$\therefore \mu_{\min} = \tan \theta$$

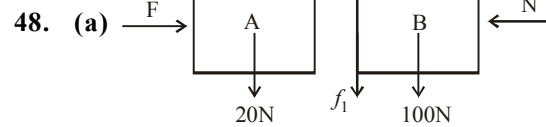

Assuming both the blocks are stationary

$$N = F$$

$$f_1 = 20 \text{ N}$$

$$f_2 = 100 + 20 = 120 \text{ N}$$

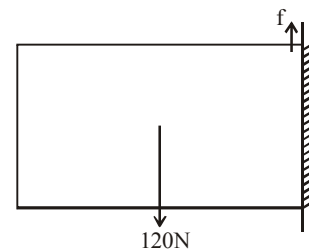

Considering the two blocks as one system and due to equilibrium $f = 120 \text{ N}$

49. (d) $f = \mu(M + m)g$

$$a = \frac{f}{M + m} = \frac{\mu(M + m)g}{(M + m)} = \mu g$$

$$= 0.05 \times 10 = 0.5 \text{ ms}^{-2}$$

$$V_0 = \frac{\text{Initial momentum}}{(M + m)} = \frac{0.05V}{10.05}$$

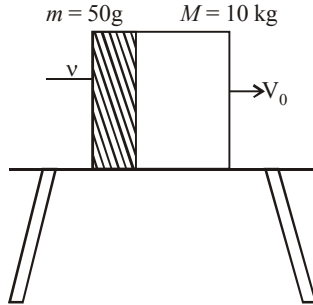

$$v^2 - u^2 = 2as$$

$$0 - u^2 = 2as$$

$$u^2 = 2as$$

$$\left(\frac{0.05v}{10.05}\right)^2 = 2 \times 0.5 \times 2$$

Solving we get $v = 201\sqrt{2}$

Object falling from height H .

$$\frac{V}{10} = \sqrt{2gH}$$

$$\frac{201\sqrt{2}}{10} = \sqrt{2 \times 10 \times H}$$

$$H = 40 \text{ m} = 0.04 \text{ km}$$

50. (a) At limiting equilibrium,

$$\mu = \tan \theta$$

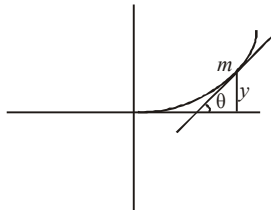

$$\tan \theta = \mu = \frac{dy}{dx} = \frac{x^2}{2} \text{ (from question)}$$

$$\therefore \text{Coefficient of friction } \mu = 0.5$$

$$\therefore 0.5 = \frac{x^2}{2}$$

$$\Rightarrow x = \pm 1$$

$$\text{Now, } y = \frac{x^3}{6} = \frac{1}{6}m$$

51. (d) Force of friction at point P,

$$F_{\text{friction}} = \frac{1}{3}Ma \sin \theta$$

$$= \frac{1}{3}Ma \sin 90^\circ \text{ [here } \theta = 90^\circ \text{]}$$

$$= \frac{Ma}{3}$$

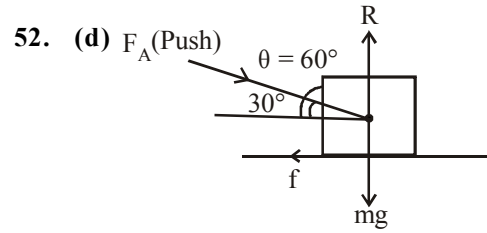

$$F_A = \frac{\mu mg}{\sin \theta - \mu \cos \theta}$$

Similarly,

$$F_B = \frac{\mu mg}{\sin \theta + \mu \cos \theta}$$

$$\therefore \frac{F_A}{F_B} = \frac{\frac{\mu mg}{\sin \theta - \mu \cos \theta}}{\frac{\mu mg}{\sin \theta + \mu \cos \theta}}$$

$$= \frac{\mu mg}{\sin 60^\circ - \frac{\sqrt{3}}{5} \cos 60^\circ} \left[\mu = \frac{\sqrt{3}}{5} \text{ given} \right]$$

$$= \frac{\mu mg}{\sin 30^\circ + \frac{\sqrt{3}}{5} \cos 30^\circ} = \frac{\sin 30^\circ + \frac{\sqrt{3}}{5} \cos 30^\circ}{\sin 60^\circ - \frac{\sqrt{3}}{5} \cos 60^\circ}$$

$$= \frac{\frac{1}{2} + \frac{\sqrt{3}}{5} \times \frac{\sqrt{3}}{2}}{\frac{\sqrt{3}}{2} - \frac{\sqrt{3}}{5} \times \frac{1}{2}}$$

$$= \frac{\frac{1}{2} \left(1 + \frac{3}{5}\right)}{\frac{\sqrt{3}}{5} \left(1 - \frac{1}{5}\right)} = \frac{\frac{1}{2} \times \frac{8}{5}}{\frac{\sqrt{3} \times 4}{10}}$$

$$= \frac{\frac{8}{10}}{\frac{\sqrt{3} \times 4}{10}} = \frac{8}{\sqrt{3} \times 4} = \frac{2}{\sqrt{3}}$$

53. (b) Initial speed at point A, $u = v_0$

Speed at point B, $v = ?$

$$v^2 - u^2 = 2gh$$

$$v^2 = v_0^2 + 2gh$$

Let ball travels distance 'S' before coming to rest

$$S = \frac{v^2}{2\mu g} = \frac{v_0^2 + 2gh}{2\mu g}$$

$$= \frac{v_0^2}{2\mu g} + \frac{2gh}{2\mu g} = \frac{h}{\mu} + \frac{v_0^2}{2\mu g}$$



54. (c) Minimum force on A
= frictional force between the surfaces
= 12 N

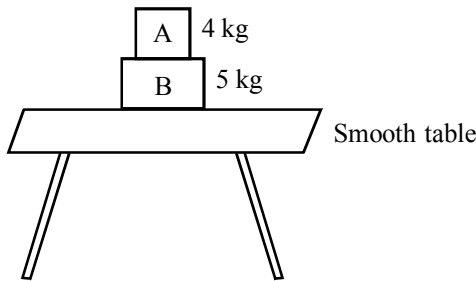

Therefore maximum acceleration

$$a_{\max} = \frac{12\text{N}}{4\text{kg}} = 3\text{m/s}^2$$

Hence maximum force,

$$F_{\max} = \text{total mass} \times a_{\max} \\ = 9 \times 3 = 27\text{N}$$

55. (b) Graph (b) correctly depicts the acceleration-time graph of the block.
56. (d) When the body has maximum speed then
 $\mu = 0.3x = \tan 45^\circ$
 $\therefore x = 3.33\text{m}$
57. (a) Let the force F is applied at an angle θ with the horizontal.

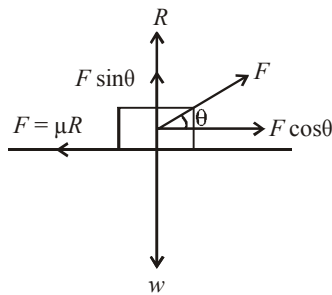

For horizontal equilibrium,
 $F \cos \theta = \mu R$... (i)

For vertical equilibrium,
 $R + F \sin \theta = mg$
or, $R = mg - F \sin \theta$... (ii)

Substituting this value of R in eq. (i), we get
 $F \cos \theta = \mu (mg - F \sin \theta)$
 $= \mu mg - \mu F \sin \theta$
or, $F (\cos \theta + \mu \sin \theta) = \mu mg$

$$\text{or, } F = \frac{\mu mg}{\cos \theta + \mu \sin \theta} \quad \dots \text{(iii)}$$

For F to be minimum, the denominator $(\cos \theta + \mu \sin \theta)$ should be maximum.

$$\therefore \frac{d}{d\theta} (\cos \theta + \mu \sin \theta) = 0$$

$$\text{or, } -\sin \theta + \mu \cos \theta = 0$$

$$\text{or, } \tan \theta = \mu$$

$$\text{or, } \theta = \tan^{-1}(\mu)$$

Then, $\sin \theta = \frac{\mu}{\sqrt{1+\mu^2}}$ and

$$\cos \theta = \frac{1}{\sqrt{1+\mu^2}}$$

Hence, F_{\min}

$$= \frac{\mu w}{\frac{1}{\sqrt{1+\mu^2}} + \frac{\mu^2}{\sqrt{1+\mu^2}}} = \frac{\mu w}{\sqrt{1+\mu^2}}$$

58. (a)

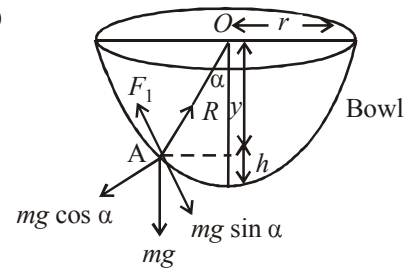

The insect crawls up the bowl upto a certain height h only till the component of its weight along the bowl is balanced by limiting frictional force.

For limiting condition at point A

$$R = mg \cos \alpha \quad \dots \text{(i)}$$

$$F_1 = mg \sin \alpha \quad \dots \text{(ii)}$$

Dividing eq. (ii) by (i)

$$\tan \alpha = \frac{1}{\cot \alpha} = \frac{F_1}{R} = \mu \quad [As \ F_1 = \mu R]$$

$$\Rightarrow \tan \alpha = \mu = \frac{1}{3} \quad [\because \mu = \frac{1}{3} \text{ (Given)}]$$

$$\therefore \cot \alpha = 3$$

59. (c)

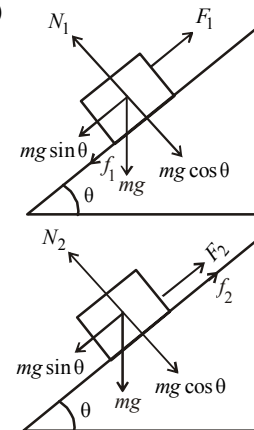

When the body slides up the inclined plane, then
 $mg \sin \theta + f_1 = F_1$

$$\text{or, } F_1 = mg \sin \theta + \mu mg \cos \theta$$

When the body slides down the inclined plane, then
 $mg \sin \theta - f_2 = F_2$

$$\text{or, } F_2 = mg \sin \theta - \mu mg \cos \theta$$

$$\therefore \frac{F_1}{F_2} = \frac{\sin \theta + \mu \cos \theta}{\sin \theta - \mu \cos \theta}$$

$$\Rightarrow \frac{F_1}{F_2} = \frac{\tan \theta + \mu}{\tan \theta - \mu} = \frac{2\mu + \mu}{2\mu - \mu} = \frac{3\mu}{\mu} = 3$$

60. (d) It is given $\ell_A : \ell_B = 2 : 3$

$$\ell_A = \frac{2\ell}{5}, \ell_B = \left(\frac{3\ell}{5}\right)$$

\therefore We know that $k \propto \frac{1}{\ell}$

If initial spring constant is k , then

$$k\ell = k_A \ell_A = k_B \ell_B$$

$$k\ell = k_A \left(\frac{2\ell}{5}\right)$$

$$k_A = \frac{5k}{2}$$

61. (b)

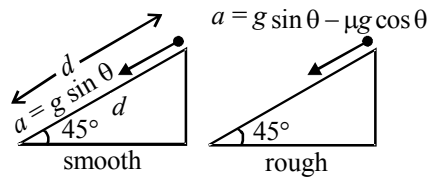

On smooth inclined plane, acceleration of the body = $g \sin \theta$. Let d be the distance travelled

$$\therefore d = \frac{1}{2}(g \sin \theta)t_1^2,$$

$$t_1 = \sqrt{\frac{2d}{g \sin \theta}},$$

On rough inclined plane,

$$a = \frac{mg \sin \theta - \mu R}{m}$$

$$\Rightarrow a = \frac{mg \sin \theta - \mu mg \cos \theta}{m}$$

$$\Rightarrow a = g \sin \theta - \mu_k g \cos \theta$$

$$\therefore d = \frac{1}{2}(g \sin \theta - \mu_k g \cos \theta)t_2^2$$

$$t_2 = \sqrt{\frac{2d}{g \sin \theta - \mu_k g \cos \theta}}$$

According to question, $t_2 = nt_1$

$$n \sqrt{\frac{2d}{g \sin \theta}} = \sqrt{\frac{2d}{g \sin \theta - \mu_k g \cos \theta}}$$

Here, μ is coefficient of kinetic friction as the block moves over the inclined plane.

$$\therefore \sin \theta = (\sin \theta - \mu_k \cos \theta)n^2$$

$$\Rightarrow n = \frac{1}{\sqrt{1 - \mu_k}} \Rightarrow n^2 = \frac{1}{1 - \mu_k}$$

$$\Rightarrow \mu_k = 1 - \frac{1}{n^2}$$

62. (d) For first half acceleration = $g \sin \phi$; For second half

$$\text{acceleration} = -(g \sin \phi - \mu g \cos \phi)$$

For the block to come to rest at the bottom, acceleration in I half = retardation in II half.

$$g \sin \phi = -(g \sin \phi - \mu g \cos \phi)$$

$$\Rightarrow \mu = 2 \tan \phi$$

NOTE

According to work-energy theorem, $W = \Delta K = 0$

(Since initial and final speeds are zero)

\therefore Workdone by friction + Work done by gravity = 0

$$\text{i.e., } -(\mu mg \cos \phi) \frac{\ell}{2} + mg \ell \sin \phi = 0$$

$$\text{or } \frac{\mu}{2} \cos \phi = \sin \phi \text{ or } \mu = 2 \tan \phi$$

63. (a) Given, initial velocity, $u = 100 \text{ m/s}$.

Final velocity, $v = 0$.

Acceleration, $a = \mu_k g = 0.5 \times 10$

$$v^2 - u^2 = 2as \text{ or}$$

$$\Rightarrow 0^2 - u^2 = 2(-\mu_k g)s$$

$$\Rightarrow -100^2 = 2 \times -\frac{1}{2} \times 10 \times s$$

$$\Rightarrow s = 1000 \text{ m}$$

64. (c)

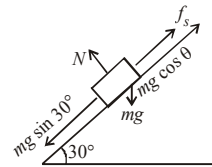

Since the body is at rest on the inclined plane,

$$mg \sin 30^\circ = \text{Force of friction}$$

$$\Rightarrow m \times 10 \times \sin 30^\circ = 10$$

$$\Rightarrow m \times 5 = 10 \Rightarrow m = 2.0 \text{ kg}$$

65. (d) Horizontal force, $N = 10 \text{ N}$.

Coefficient of friction $\mu = 0.2$.

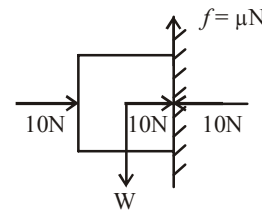

The block will be stationary so long as

Force of friction = weight of block

$$\therefore \mu N = W$$

$$\Rightarrow 0.2 \times 10 = W$$

$$\Rightarrow W = 2 \text{ N}$$

66. (d) $u = 6 \text{ m/s}$, $v = 0$, $t = 10 \text{ s}$, $a = ?$

$$\text{Acceleration } a = \frac{v - u}{t}$$

$$\Rightarrow a = \frac{0 - 6}{10}$$

$$\Rightarrow a = \frac{-6}{10} = -0.6 \text{ m/s}^2$$

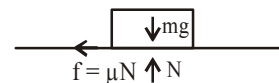

The retardation is due to the frictional force

$$\therefore f = ma \Rightarrow \mu N = ma$$

$$\Rightarrow \mu mg = ma \Rightarrow \mu = \frac{ma}{mg}$$

$$\Rightarrow \mu = \frac{a}{g} = \frac{0.6}{10} = 0.06$$

67. (d) Using, $\mu mg = \frac{mv^2}{r} = mr\omega^2$
 $\omega = 2\pi n = 2\pi \times 3.5 = 7\pi$ rad/sec
 Radius, $r = 1.25$ cm = 1.25×10^{-2} m
 Coefficient of friction, $\mu = ?$

$$\mu mg = \frac{m(r\omega)^2}{r} (\because v = r\omega)$$

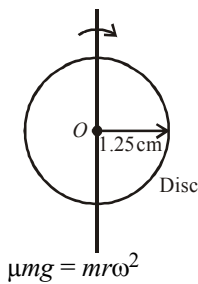

$$\mu mg = mr\omega^2$$

$$\Rightarrow \mu = \frac{r\omega^2}{g} = \frac{1.25 \times 10^{-2} \times \left(7 \times \frac{22}{7}\right)^2}{10}$$

$$= \frac{1.25 \times 10^{-2} \times 22^2}{10} = 0.6$$

68. (d) Given, $\theta = 45^\circ$, $r = 0.4$ m, $g = 10$ m/s²
 $T \sin \theta = \frac{mv^2}{r}$ (i)
 $T \cos \theta = mg$ (ii)
 From equation (i) & (ii) we have,

$$\tan \theta = \frac{v^2}{rg}$$

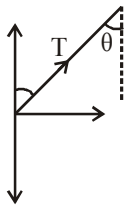

$$v^2 = rg \quad \because \theta = 45^\circ$$

Hence, speed of the pendulum in its circular path,

$$v = \sqrt{rg} = \sqrt{0.4 \times 10} = 2$$
 m/s

69. (c) 70. (a)
 71. (d) $s = t^3 + 5$

$$\Rightarrow \text{velocity, } v = \frac{ds}{dt} = 3t^2$$

$$\text{Tangential acceleration } a_t = \frac{dv}{dt} = 6t$$

$$\text{Radial acceleration } a_c = \frac{v^2}{R} = \frac{9t^4}{R}$$

$$\text{At } t = 2\text{s, } a_t = 6 \times 2 = 12 \text{ m/s}^2$$

$$a_c = \frac{9 \times 16}{20} = 7.2 \text{ m/s}^2$$

\therefore Resultant acceleration

$$= \sqrt{a_t^2 + a_c^2}$$

$$= \sqrt{(12)^2 + (7.2)^2} = \sqrt{144 + 51.84}$$

$$= \sqrt{195.84} = 14 \text{ m/s}^2$$

72. (c) Clearly $\vec{a} = a_c \cos \theta (-\hat{i}) + a_c \sin \theta (-\hat{j})$
 $= \frac{-v^2}{R} \cos \theta \hat{i} - \frac{v^2}{R} \sin \theta \hat{j}$

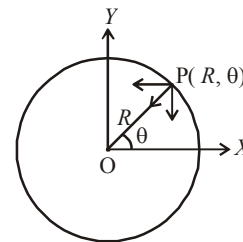

73. (c)

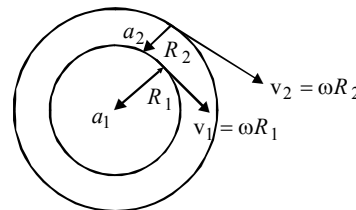

Let m is the mass of each particle and ω is the angular speed of the annular ring.

$$a_1 = \frac{v_1^2}{R_1} = \frac{\omega^2 R_1^2}{R_1} = \omega^2 R_1$$

$$a_2 = \frac{v_2^2}{R_2} = \omega^2 R_2$$

Taking particle masses equal

$$\frac{F_1}{F_2} = \frac{ma_1}{ma_2} = \frac{mR_1\omega^2}{mR_2\omega^2} = \frac{R_1}{R_2}$$

NOTE :

The force experienced by any particle is only along radial direction.

Force experienced by the particle, $F = m\omega^2 R$

$$\therefore \frac{F_1}{F_2} = \frac{R_1}{R_2}$$

74. (b) Only option (b) is false since acceleration vector is always radial (i.e. towards the center) for uniform circular motion.
 75. (b) The maximum velocity of the car is

$$v_{\max} = \sqrt{\mu rg}$$

Here $\mu = 0.6$, $r = 150$ m, $g = 9.8$

$$v_{\max} = \sqrt{0.6 \times 150 \times 9.8} \approx 30 \text{ m/s}$$